

PRODUCTOS DE
ORDENACIÓN

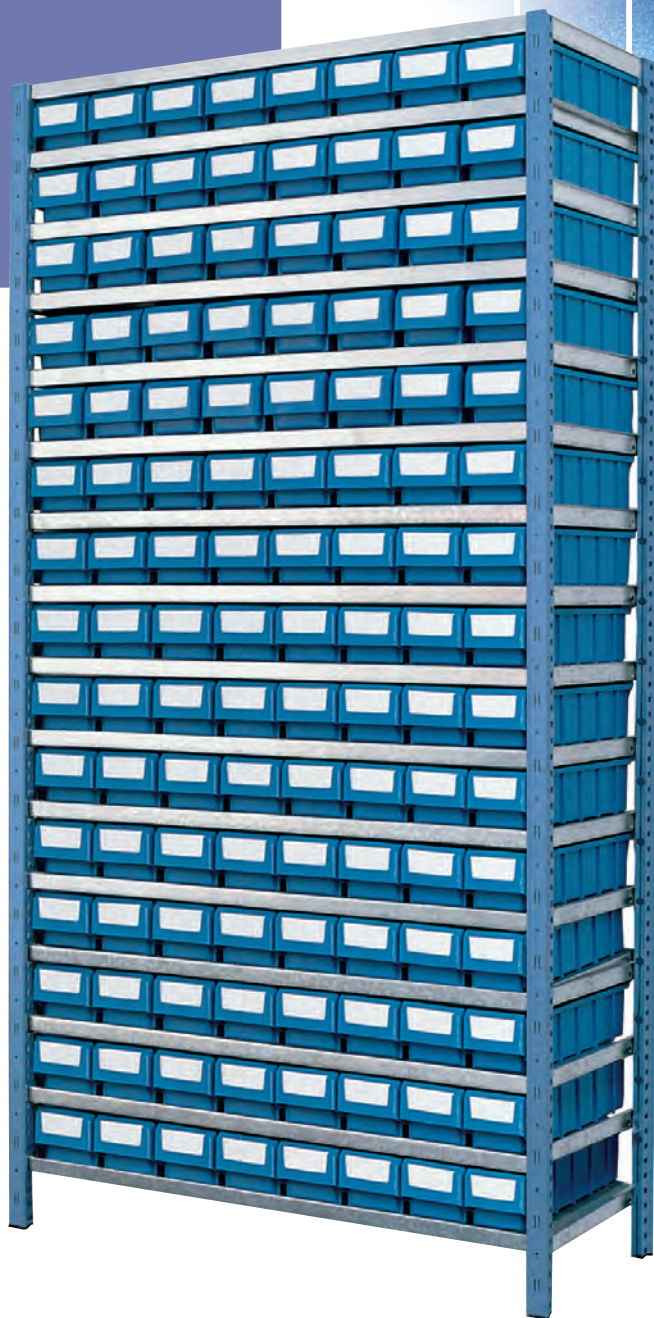



ARREGEMENT
PRODUCTS





2 PRODUCTOS DE ORDENACIÓN

ARREGEMENT PRODUCTS

- | | | | |
|--|---|---|----|
| 42 |  |  | 44 |
| GAVETAS APILABLES
STACKABLE DRAWERS | | GAVETA PLEGABLE APILABLE
STACKABLE FOLDING DRAWER | |
| 48 |  |  | 49 |
| EURO-CAJAS PARA
ALMACÉN Y TRANSPORTE
EURO BOX | | EURO-CAJAS CON TAPA
PARA ALMACÉN Y TRANSPORTE
EURO BOX WITH COVER | |
| 50 |  |  | 50 |
| CAJONES ESTANTERÍAS
DRAWERS FOR SHELVES | | SEPARADORES
DIVIDERS | |
| 51 |  |  | 52 |
| KIT ESTANTERÍA METÁLICA
METAL SHELVES KIT | | KIT ESTANTERÍA METÁLICA
CON CAJONES
METAL SHELVES KIT WITH DRAWERS | |
| 53 |  |  | 54 |
| CONTENEDORES BASCULANTES
CABINET WITH TILTABLE DRAWERS | | KIT ESTANTERÍA PLÁSTICO
PLASTIC SHELVES KIT | |
| 56 |  |  | 57 |
| MÓDULOS METÁLICOS
METAL STACKABLE MODULES | | CONTENEDORES CAJONES
CABINETS WITH DRAWERS | |
| 58 |  |  | 59 |
| CLASIFICADORES APILABLES
STACKABLE CLASSIFIERS SHELF UNIT | | MÓDULOS APILABLES
STACKABLE MODULES | |
| 59 |  |  | 60 |
| MÓDULOS BANDEJAS
TRAY MODULES | | MULTIBOX
MULTIBOX | |
| 61 |  |  | 62 |
| MULTIBOX2
MULTIBOX2 | | BIDONES CON CÁNULA (VERTEDERO)
JERRY CANS WITH SPOUT (FOR POURING) | |
| 63 |  | | |
| BIDONES CON TAPÓN/GRIFO
JERRY CANS WITH CAP/TAP | | | |



APTO PARA USO ALIMENTARIO
 Registro sanitario / Health registration
 n° 3904321/V

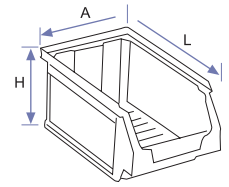
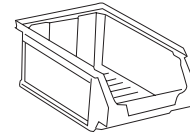
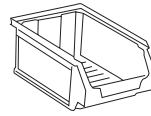
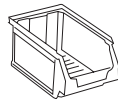

MODELO MODEL	51	52	53	54	55
CÓDIGO CODE	■ 251023 ■ 251108 □ 251344	■ 252020 ■ 252105 □ 252341	■ 253027 ■ 253102 □ 253348	■ 254024 ■ 254109 □ 254345	■ 255021 ■ 255106 □ 255342
MEDIDAS SIZES	L A H 170x100x80 mm	L A H 236x160x130 mm	L A H 336x160x130 mm	L A H 336x216x155 mm	L A H 336x216x200 mm
MATERIAL MATERIAL	PP	PP	PP	PP	PP
CAPACIDAD (Litros) Capacity (Liters)	0,8	3,2	4,8	7,7	10,1
EMBALAJE PACKING	24 unid.	15 unid.	10 unid.	12 unid.	10 unid.

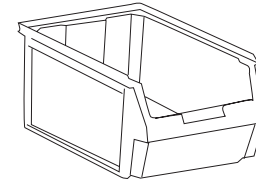
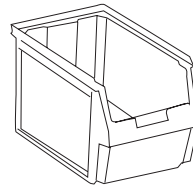
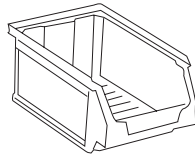
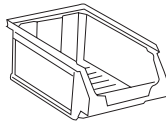

MODELO MODEL	56	58	59	60
CÓDIGO CODE	■ 256028 ■ 256103 □ 256349	■ 258022 ■ 258107 □ 258343	■ 259029 ■ 259104 □ 259340	■ 260025 ■ 260100 □ 260346
MEDIDAS SIZES	L A H 420x270x175 mm	L A H 500x303x200 mm	L A H 500x303x300 mm	L A H 600x400x300 mm
MATERIAL MATERIAL	PP	PP	PP	PP
CAPACIDAD (Litros) Capacity (Liters)	13,9	22,2	34	51,3
EMBALAJE PACKING	8 unid.	12 unid.	6 unid.	6 unid.

R.S.I
 N° 3904321/V







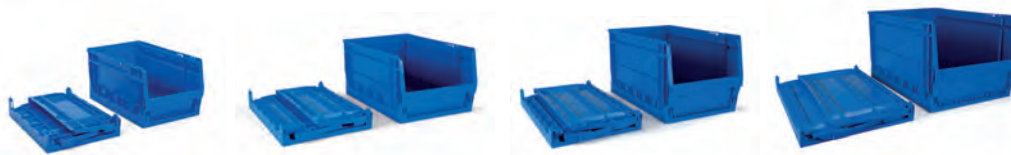

MODELO MODEL	54P	56P	59P	60P
CÓDIGO CODE	■ 204029 □ 204340	■ 206023 □ 206344	■ 209024 □ 209345	■ 210020 □ 210341
MEDIDAS SIZES	336x216x175	420x270x200	500x303x275	600x400x325
MATERIAL MATERIAL	PP	PP	PP	PP
CAPACIDAD (Litros) Capacity (Liters)	8,5	15	30	55
EMBALAJE PACKING	5	5	5	5



 **APTO PARA USO ALIMENTARIO**
 Registro sanitario / Health registration
 n° 3904321/V



MODELO MODEL	Kit Colgar G-04
CÓDIGO CODE	204906
MEDIDAS SIZES	L A H 170x487x77 mm
CONTIENE CONTAINED	3 Gavetas / 1 Colgador 3 Drawers / 1 Hanger
MATERIAL	Gaveta PP / Colgador PS Drawers PP / Hanger PS
EMBALAJE PACKING	10 unid.



MODELO MODEL	Kit Colgar G-09
CÓDIGO CODE	209901
MEDIDAS SIZES	L A H 170x520x50 mm
CONTIENE CONTAINED	5 Gavetas / 1 Colgador 5 Drawers / 1 Hanger
MATERIAL	Gaveta PP / Colgador PS Drawers PP / Hanger PS
EMBALAJE PACKING	10 unid.



MODELO MODEL	Kit Colgar G-50
CÓDIGO CODE	250903
MEDIDAS SIZES	L A H 91x520x53 mm
CONTIENE CONTAINED	5 Gavetas / 1 Colgador 5 Drawers / 1 Hanger
MATERIAL	Gaveta PP / Colgador PS Drawers PP / Hanger PS
EMBALAJE PACKING	10 unid.



MODELO MODEL	Kit Colgar G-51
CÓDIGO CODE	251900
MEDIDAS SIZES	L A H 170x520x80 mm
CONTIENE CONTAINED	5 Gavetas / 1 Colgador 5 Drawers / 1 Hanger
MATERIAL	Gaveta PP / Colgador PS Drawers PP / Hanger PS
EMBALAJE PACKING	10 unid.



APTO PARA USO ALIMENTARIO
 Registro sanitario / Health registration
 nº 3904321/V



Gaveta Ref. 52 y Ref. 52P
 Son apilables y compatibles
 Son apilables y compatibles

MODELO MODEL	52P
CÓDIGO CODE	■ 202025 □ 202346
MEDIDAS SIZES	L A H 236x160x130 mm
MATERIAL	PP
CONTIENE CONTAINED	1 Kit = 5 Gavetas flejadas 1 Kit = 5 Strapped bin boxes
EMBALAJE PACKING	8 Kits = 40 unid.

MODELO MODEL	53P
CÓDIGO CODE	■ 203022 □ 203343
MEDIDAS SIZES	L A H 336x160x130 mm
MATERIAL	PP
CONTIENE CONTAINED	1 Kit = 5 Gavetas flejadas
EMBALAJE PACKING	8 Kits = 40 unid.

Gaveta Ref. 53 y Ref. 53P
 Son apilables y compatibles
 Son apilables y compatibles

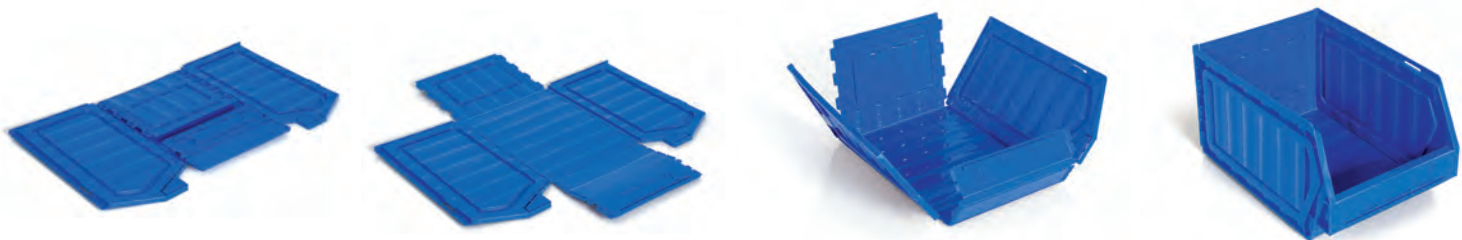
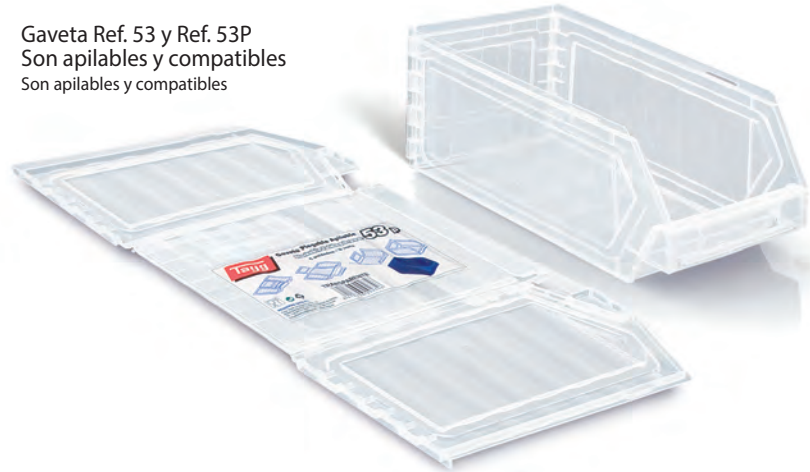

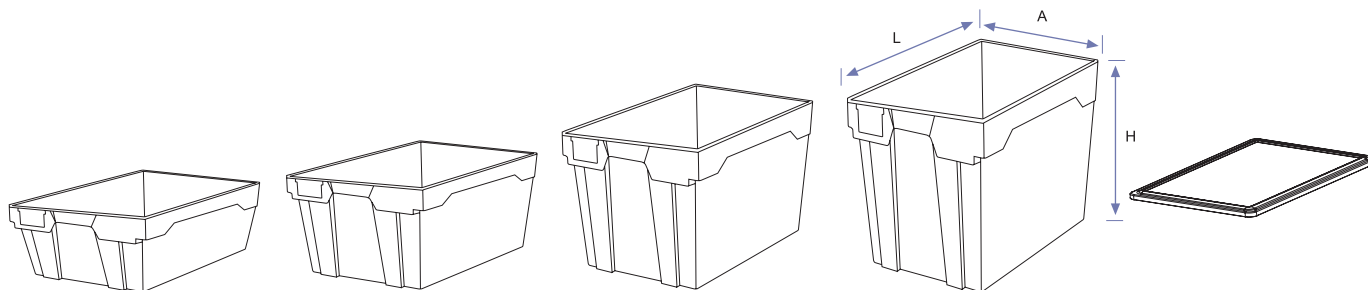

MODELO MODEL	6415	6420	6430	6440	6400
CÓDIGO CODE	■ 261008 ☐ 261299	■ 262005 ☐ 262296	■ 263002 ☐ 263293	■ 264009 ☐ 264290	■ 299001 ☐ 299292
MEDIDAS SIZES	L A H 600x400x150 mm	L A H 600x400x200 mm	L A H 600x400x300 mm	L A H 600x400x400 mm	L A H 600x405x29 mm
CAPACIDAD (Litros) Capacity (Liters)	22 L.	34 L.	51 L.	69 L.	-
PESO (KG.) WEIGHT (KG.)	1,23 Kg.	1,62 Kg.	2,16 Kg.	2,74 Kg.	0,65 Kg.
MATERIAL	PP	PP	PP	PP	PP
EMBALAJE PACKING	Retráctil 6 Palet 92	Retráctil 6 Palet 64	Retráctil 6 Palet 48	Retráctil 6 Palet 32	Retráctil 6



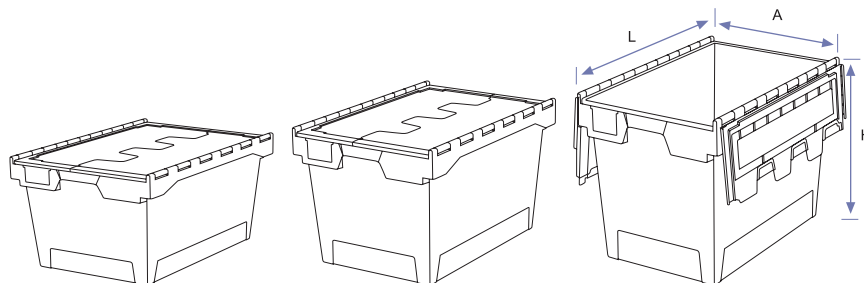

MODELO MODEL	6424-T	6434-T	6444-T
CÓDIGO CODE	■ 265006	■ 266003	■ 267000
MEDIDAS SIZES	L A H 600x400x240 mm	L A H 600x400x340 mm	L A H 600x400x440 mm
CAPACIDAD (Litros) Capacity (Liters)	39 L.	58 L.	75 L.
PESO (KG.) WEIGHT (KG.)	2,5 kg	3 kg	3,7 kg
MATERIAL MATERIAL	PP	PP	PP
EMBALAJE PACKING	Retráctil 6 Palet 56	Retráctil 6 Palet 48	Retráctil 6 Palet 32



APTO PARA USO ALIMENTARIO
Registro sanitario / Health registration
n° 3904321/V



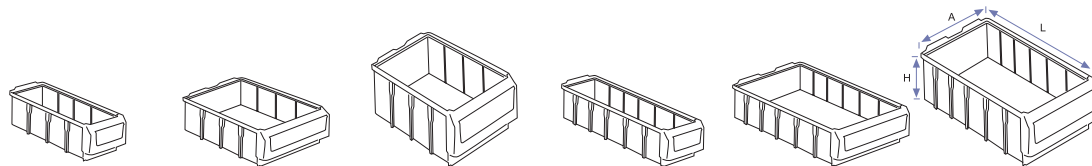

MODELO MODEL	301	302	303	401	402	403
CÓDIGO CODE	■ 355004	■ 356001	■ 357008	■ 360008	■ 361005	■ 362002
MEDIDAS SIZES	L A H 291x116x90 mm	L A H 291x232x90 mm	L A H 291x232x140 mm	L A H 391x116x90 mm	L A H 391x232x90 mm	L A H 391x232x140 mm
CAPACIDAD (Litros) Capacity (Liters)	2 L.	4,4 L.	7 L.	2,7 L.	6,1 L.	9,7 L.
MATERIAL MATERIAL	Cajones PP	Cajones PP	Cajones PP	Cajones PP	Cajones PP	Cajones PP
EMBALAJE PACKING	20 unid.	10 unid.	8 unid.	20 unid.	10 unid.	8 unid.



SEPARADORES

Dividers

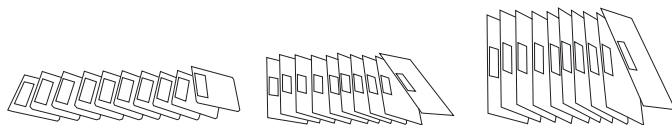

MODELO MODEL	01	02	03
CÓDIGO CODE	■ 390005	■ 391002	■ 392009
MEDIDAS SIZES	103x79 mm	219x79 mm	219x129 mm
MATERIAL MATERIAL	PP	PP	PP
EMBALAJE PACKING	20 unid.	10 unid.	10 unid.

MODELO MODEL	300	400
CÓDIGO CODE	398001	399008
MEDIDAS SIZES	L A H 1030x337x2000 mm	L A H 1030x437x2000 mm
CONTIENE CONTAINED	4 Puntales 16 Bandejas 300 Acc. 16 Bandejas 300	4 Puntales 16 Bandejas 400 Acc. 16 Bandejas 400

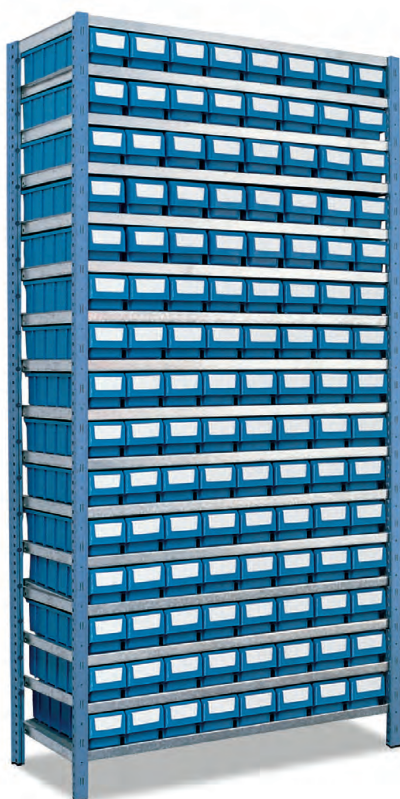

MODELO MODEL	Kit estantería 301
CÓDIGO CODE	398308
CONTIENE CONTAINED	1 Estantería 300 (16 Bandejas) 120 Cajones 301 18 20-Separadores 01

MODELO MODEL	Kit estantería 401
CÓDIGO CODE	399305
CONTIENE CONTAINED	1 Estantería 400 (16 Bandejas) 120 Cajones 401 30 20-Separadores 01

MODELO MODEL	Kit estantería 302
CÓDIGO CODE	398315
CONTIENE CONTAINED	1 estantería 300 (16 Bandejas) 60 Cajones 302 18 10-Separadores 02

MODELO MODEL	Kit estantería 402
CÓDIGO CODE	399312
CONTIENE CONTAINED	1 estantería 400 (16 Bandejas) 60 Cajones 402 30 10-Separadores 02

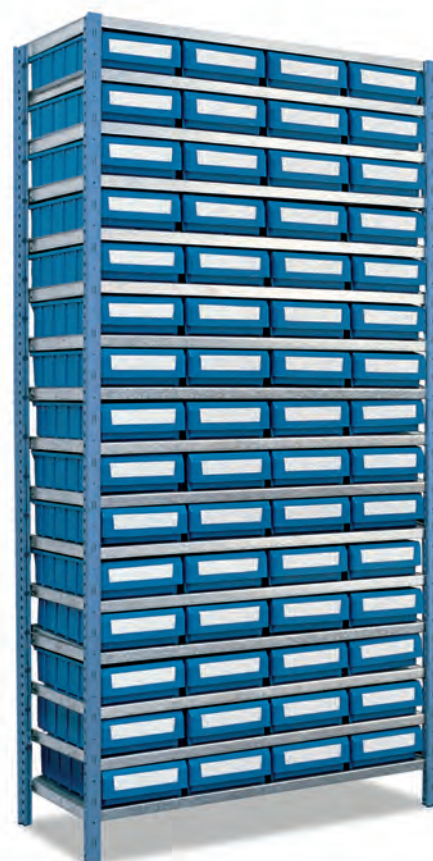

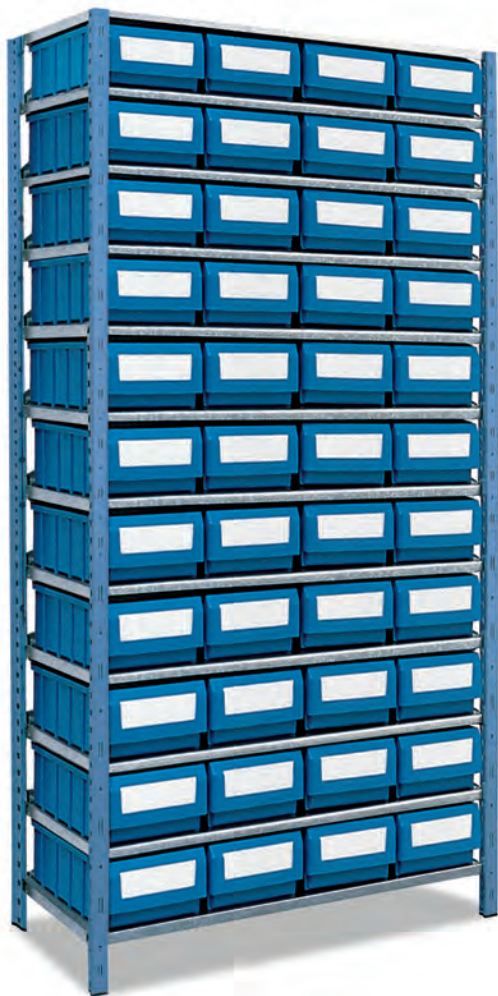

MODELO MODEL	Kit estantería 303	Kit estantería 403
CÓDIGO CODE	398322	399329
CONTIENE CONTAINED	1 estantería 300 (12 Bandejas) 48 Cajones 303 13 10-Separadores 03	1 estantería 400 (12 Bandejas) 48 Cajones 403 15 10-Separadores 03

MODELO MODEL	Kit estantería 310	Kit estantería 410
CÓDIGO CODE	398339	399336
CONTIENE CONTAINED	1 estantería 300 (15 Bandejas) 40 Cajones 301 20 Cajones 302 16 Cajones 303 6-20 Separadores 01 6-10 Separadores 02 4-10 Separadores 03	1 estantería 400 (15 Bandejas) 40 Cajones 401 20 Cajones 402 16 Cajones 403 10-20 Separadores 01 10-10 Separadores 02 8-10 Separadores 03

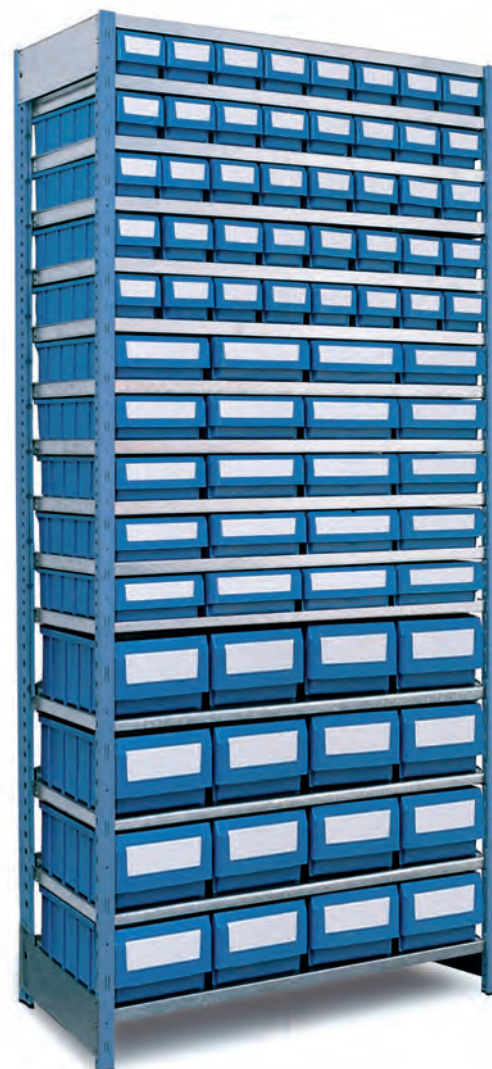

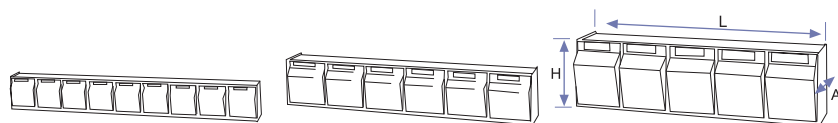

CÓDIGO CODE	339066	336065	335068
CAJONES DRAWERS	9	6	5
MEDIDAS SIZES	L A H 600x63x81	L A H 600x92x114	L A H 600x133x165
MATERIAL MATERIAL	PS	PS	PS
EMBALAJE PACKING	12 unid.	12 unid.	6 unid.

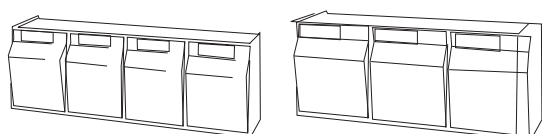

CÓDIGO CODE	334061	333064
CAJONES DRAWERS	4	3
MEDIDAS SIZES	600x168x206	600x196x241
MATERIAL MATERIAL	PS	PS
EMBALAJE PACKING	6 unid.	4 unid.

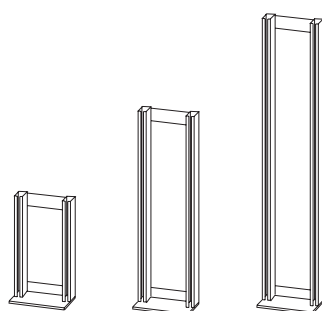

SOPORTE CÓDIGO CODE	340000	341007	342004
MEDIDAS SIZES	60 cm	121 cm	177 cm

VARILLA
CIERRE



CÓDIGO CODE	343001 VARILLA CIERRE
CÓDIGO CODE	344008 (10 tornillos y arandelas)

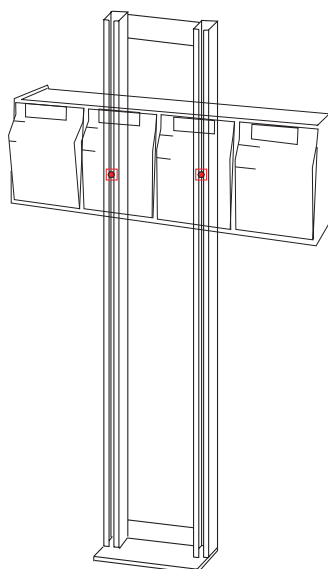

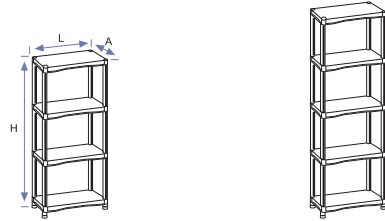

MODELO MODEL	634	635
CÓDIGO CODE	228001	227004
MEDIDAS SIZES	L A H 600x300x1370 mm	L A H 600x300x1800 mm
CONTIENE CONTAINED	4 Bandejas 12 Puntales 4 Tapones 4 Pies 2 Soportes estantería	5 Bandejas 16 Puntales 4 Tapones 4 Pies 2 Soportes estantería
MATERIAL MATERIAL	Resina PP	Resina PP
EMBALAJE PACKING	1 unid.	1 unid.

*No se necesitan herramientas para su montaje.
Se monta en 10 minutos.
Fácil limpieza.
Pies elevados.
Baldas reforzadas.
Resina de polipropileno.
Ecológica. 100% reciclable.
Doble soporte de fijación en pared.
Presentación en paquete retractilado fácilmente transportable.



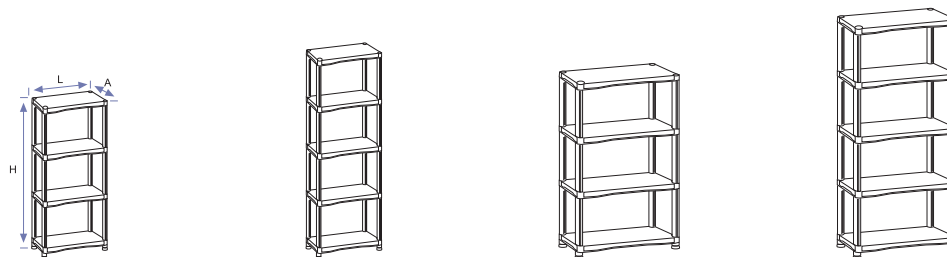

MODELO MODEL	744	745	944	945
CÓDIGO CODE	226007	225000	221002	220005
MEDIDAS SIZES	L A H 700x400x1366 mm	L A H 700x400x1800 mm	L A H 900x400x1366 mm	L A H 900x400x1800 mm
CONTIENE CONTAINED	4 Bandejas 12 Puntales 16 Casquillos reguladores 4 Tapones 4 Pies 2 Soportes estantería	5 Bandejas 16 Puntales 20 Casquillos reguladores 6 Tapones 6 Pies 3 Soportes estantería	4 Bandejas 12 Puntales 16 Casquillos reguladores 4 Tapones 4 Pies 2 Soportes estantería	5 Bandejas 16 Puntales 20 Casquillos reguladores 6 Tapones 6 Pies 3 Soportes estantería
MATERIAL MATERIAL	Resina PP	Resina PP	Resina PP	Resina PP
EMBALAJE PACKING	1 unid.	1 unid.	1 unid.	1 unid.

*No se necesitan herramientas para su montaje.
 Se monta en 10 minutos.
 Fácil limpieza.
 Pies elevados.
 Balda regulable en altura.
 Baldas reforzadas.
 Resina de polipropileno.
 Ecológica. 100% reciclable.
 Doble soporte de fijación en pared.
 Presentación en paquete retráctilado fácilmente transportable.



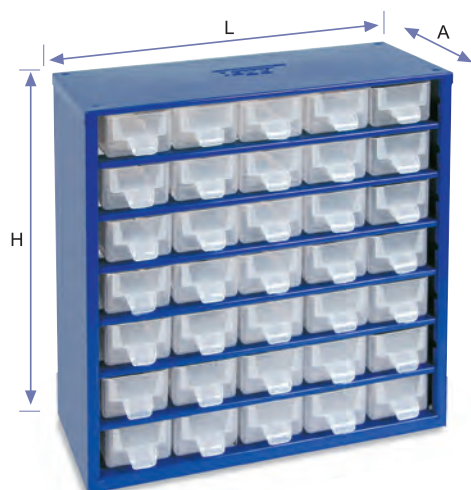

MODELO MODEL	35/0/0
CÓDIGO CODE	316005
MEDIDAS SIZES	305x145x328 mm
EMBALAJE PACKING	4 unid.
MATERIAL MATERIAL	Armazón-Chapa de acero-Pintura epoxi <i>Frame-Steel sheet</i> Cajones PP <i>Drawers</i>



MODELO MODEL	20/2/1
CÓDIGO CODE	315008
MEDIDAS SIZES	LxAxH 305x145x328 mm
EMBALAJE PACKING	4 unid.
MATERIAL MATERIAL	Armazón-Chapa de acero-Pintura epoxi <i>Frame-Steel sheet</i> Cajones PP <i>Drawers</i>



MODELO MODEL	10/2/1
CÓDIGO CODE	317002
MEDIDAS SIZES	305x145x237 mm
EMBALAJE PACKING	4 unid.
MATERIAL MATERIAL	Armazón-Chapa de acero-Pintura epoxi <i>Frame-Steel sheet</i> Cajones PP <i>Drawers</i>



MODELO MODEL	25/0/0
CÓDIGO CODE	318009
MEDIDAS SIZES	305x145x237 mm
EMBALAJE PACKING	4 unid.
MATERIAL MATERIAL	Armazón-Chapa de acero-Pintura epoxi <i>Frame-Steel sheet</i> Cajones PP <i>Drawers</i>

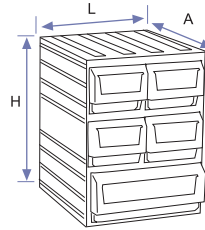
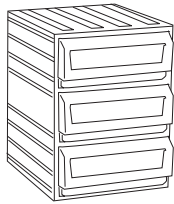
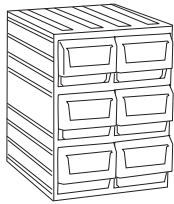

MODELO MODELO	300/6	300/3	300/5
CÓDIGO CODE	350009	351006	352003
MEDIDAS EXTERIORES OUTER SIZES	LxAxH 245x291x321 mm	LxAxH 245x291x321 mm	LxAxH 245x291x321 mm
CAJONES DRAWERS MEDIDAS SIZES	6 291x116x95 mm	3 291x232x95 mm	4 291x116x95 mm 1 291x232x95 mm
SEPARADOR CAJONES DRAWERS SEPARATOR	18 sep-01	9 sep-02	12 sep-01 3 sep-02
MATERIAL MATERIAL	Armazón PS Frame Cajones PP Drawers	Armazón PS Frame Cajones PP Drawers	Armazón PS Frame Cajones PP Drawers
EMBALAJE PACKING	2 unid.	2 unid.	2 unid.



Ensamble sobre guías
Assembling on guides

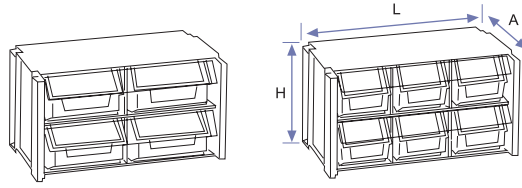

CÓDIGO CODE	304002	306006
MEDIDAS EXTERIORES OUTER SIZES	LxAxH 360x170x190 mm	LxAxH 360x170x190 mm
GAVETAS DRAWERS	4	6
MEDIDAS GAVETAS DRAWER SIZES	160x170x80 mm	100x170x80 mm
MATERIAL MATERIAL	Armazón PS Frame Gavetas PP Drawers	Armazón PS Frame Gavetas PP Drawers
EMBALAJE PACKING	4 unid.	4 unid.

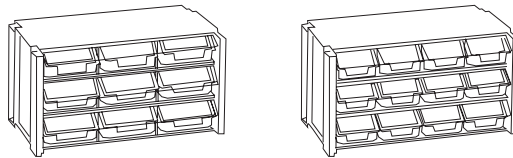

CÓDIGO CODE	309007	312007
MEDIDAS EXTERIORES OUTER SIZES	LxAxH 360x170x190 mm	LxAxH 360x170x190 mm
GAVETAS DRAWERS	9	12
MEDIDAS GAVETAS DRAWER SIZES	100x170x50 mm	80x170x50 mm
MATERIAL MATERIAL	Armazón PS Frame Gavetas PP Drawers	Armazón PS Frame Gavetas PP Drawers
EMBALAJE PACKING	4 unid.	4 unid.





CÓDIGO CODE	346002	347009	348006
MEDIDAS EXTERIORES OUTER SIZES	LxAxH 280x167x140 mm	LxAxH 280x167x140 mm	LxAxH 280x167x140 mm
CAJONES TRAY MEDIDAS SIZES	6 150x127x37 mm	3 150x127x37 mm 6 150x62x37 mm	12 150x62x37 mm
SEPARADOR CAJONES DRAWERS SEPARATOR	6 unid.	3 unid. 6 unid.	12 unid.
MATERIAL MATERIAL	PS	PS	PS
EMBALAJE PACKING	6 unid.	6 unid.	6 unid.



MÓDULOS BANDEJAS

Tray Modules



CÓDIGO CODE	321009	322006	323003
MEDIDAS EXTERIORES OUTER SIZES	LxAxH 290x167x255 mm	LxAxH 290x167x255 mm	LxAxH 290x167x255 mm
BANDEJA TRAY MEDIDAS SIZES	3 256x162x65 mm	1 256x162x65 mm 4 256x162x30 mm	6 256x162x30 mm
MATERIAL MATERIAL	Armazón PS Frame Bandeja PP Tray	Armazón PS Frame Bandeja PP Tray	Armazón PS Frame Bandeja PP Tray
EMBALAJE PACKING	4 unid.	4 unid.	4 unid.



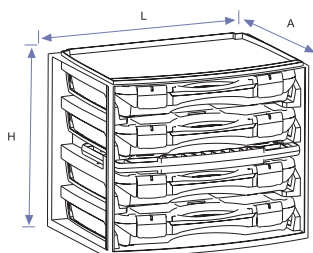

MODELO MODELO	Multibox nº1
CÓDIGO CODE	301001
MEDIDAS SIZES	LxAxH 335x250x275 mm
CONTIENE CONTAINED	Módulo + 4 estuches 22 + asa
MATERIAL MATERIAL	PP
EMBALAJE PACKING	2 unid.



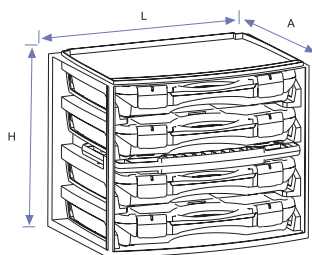

MODELO MODELO	Multibox nº2
CÓDIGO CODE	302008
MEDIDAS SIZES	360x447x314
CONTIENE CONTAINED	Módulo + 4 estuches 23
MATERIAL MATERIAL	PP
EMBALAJE PACKING	2 unid.



BIDONES CON CÁNULA (VERTEDERO)

Jerry Cans with Spout (for Pouring)

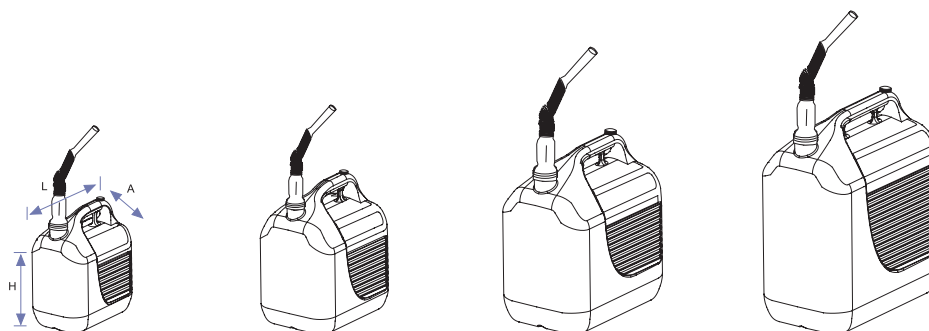

CÓDIGO CODE	601354	602351	603358	604355
CAPACIDAD CAPACIDAD	5 l.	10 l.	20 l.	30 l.
MEDIDAS SIZES	LxAxH 230x145x257 mm	LxAxH 265x200x307 mm	LxAxH 345x234x377 mm	LxAxH 400x237x464 mm
MATERIAL MATERIAL	HDPE	HDPE	HDPE	HDPE
EMBALAJE PACKING.	6 unid.	6 unid.	5 unid.	5 unid.



Homologados para transporte de mercancías peligrosas clases 3, 6.1, 8 y 9
Norma ADR (Transporte Internacional Carretera)
Norma RID (Transporte Internacional por Ferrocarril)
Norma IMDG (Transporte Internacional Marítimo)
Norma IATA/OACI (Transporte Internacional Aéreo)

PRESIÓN HIDRÁULICA 200 KPa

Toma de aire para garantizar un vertido uniforme.

CLASE CLASS	GRUPO GROUP	DESCRIPCIÓN DESCRIPTION	EJEMPLOS EXAMPLES
3	Y	INFLAMABLES	Gasolina, gasoil, otros hidrocarburos, acetona, alcoholes (metanol, etanol...) aldehidos, benceno, tolueno, xileno, éteres, ésteres, aceites, disolventes, lacas, pinturas, esmaltes, barniz...
6.1	Y	TÓXICOS	Anilinas, cloroformo, desinfectantes, plaguicidas, bencidina y compuestos de: mercurio, plomo, bario, berilio, arsénio, antimonio talio, cianuro...
8	Y	CORROSIVOS	Ácidos (sulfúrico, nítrico, fosfórico, acético, fórmico...) sulfumán Hidróxidos de: potasio, sosa, litio... Lejías, amoníaco, electrolitos, soluciones cáusticas...
9	Y	VARIOS	Amiantos, difenilos policlorados, material líquido peligroso para el medio ambiente...



TAPONES Y CÁNULAS

Caps and Spouts



CÓDIGO CODE	607004	608001	616006
CAPACIDAD CAPACIDAD	5 l. y 10 l.	20 l. y 30 l.	5 l., 10 l., 20 l. y 30 l.



CÓDIGO CODE	605000	606007
CAPACIDAD CAPACIDAD	5 l. y 10 l.	20 l. y 30 l.

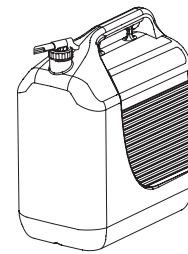
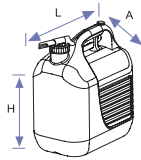

CÓDIGO CODE	601361	602368	603365	604362
CAPACIDAD CAPACITY	5 l.	10 l.	20 l.	30 l.
MEDIDAS SIZES	LxAxH 230x145x257 mm	LxAxH 265x200x307 mm	LxAxH 345x234x377 mm	LxAxH 400x237x464 mm
MATERIAL MATERIAL	HDPE	HDPE	HDPE	HDPE
EMBALAJE PACKING.	6 unid.	6 unid.	5 unid.	5 unid.

Toma de aire
para garantizar un
vertido uniforme.



 **APTO PARA USO ALIMENTARIO**
Registro sanitario / Health registration
nº 3900923/V

TAPÓN GRIFO

Cap Tap

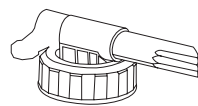
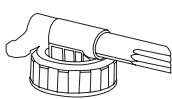

CÓDIGO CODE	609008	610004	617003
CAPACIDAD CAPACITY	5 l. y 10 l.	20 l. y 30 l.	5 l., 10 l., 20 l. y 30 l.

