

CAJAS DE
HERRAMIENTAS

TOOL BOXES



1 CAJAS DE HERRAMIENTAS

TOOL BOXES

- | | | |
|---|---|---|
| <p>8
ESTUCHES CON
COMPARTIMENTOS FIJOS
BOXES WITH FIXED DISTRIBUTION</p> |  | <p>9
ESTUCHES CON
SEPARADORES FIJOS Y MÓVILES
BOXES WITH FIXED AND MOBILE DIVIDERS</p> |
| <p>10
ESTUCHES CON
SEPARADORES MÓVILES
BOXES WITH MOBILE DIVIDERS</p> |  | <p>11
ESTUCHES CON
SEPARADORES FIJOS Y MÓVILES
BOXES WITH FIXED AND MOBILE DIVIDERS</p> |
| <p>12
ESTUCHES CON
CAJONES EXTRAÍBLES
BOXES WITH REMOVABLE DRAWERS</p> |  | <p>15
COLECCIÓN HOGAR 30 L
HOME COLLECTION</p> |
| <p>16
COLECCIÓN HOGAR
HOME COLLECTION</p> |  | <p>18
MALETAS HERRAMIENTAS
ELÉCTRICAS
CASES FOR ELECTRICAL TOOLS</p> |
| <p>19
MALETINES HERRAMIENTAS
MANUALES
CASES FOR MANUAL TOOLS</p> |  | <p>21
CAJAS HERRAMIENTAS
PLÁSTICO
PLASTIC TOOL BOXES</p> |
| <p>28
CAJAS HERRAMIENTAS
PLÁSTICO-ALUMINIO
PLASTIC-ALUMINIUM TOOL BOXES</p> |  | <p>32
COFRE HERRAMIENTAS MÓVIL
MOBILE TOOL CHEST</p> |
| <p>33
TRAIL BOX
TRAIL BOX</p> |  | <p>36
CAJAS HERRAMIENTAS METÁLICAS
METAL TOOL BOXES</p> |
| <p>37
CARROS TALLER
PORTA-HERRAMIENTAS MÓVILES
TOOL TROLLEY</p> |  | <p>38
BOLSAS HERRAMIENTAS
TOOL BAGS</p> |
| <p>39
BOLSILLOS HERRAMIENTAS
TOOL POCKET</p> |  | |



MODELO MODEL	11-12	11-7	12-21	12-11
CÓDIGO CODE	050107	051104	060106	061103
MEDIDAS SIZES	250 x 140 x 54mm	250 x 140 x 54mm	290 x 195 x 54 mm	290 x 195 x 54 mm
MATERIAL MATERIAL	PP	PP	PP	PP
EMBALAJE PACKING	6 unid.	6 unid.	6 unid.	6 unid.

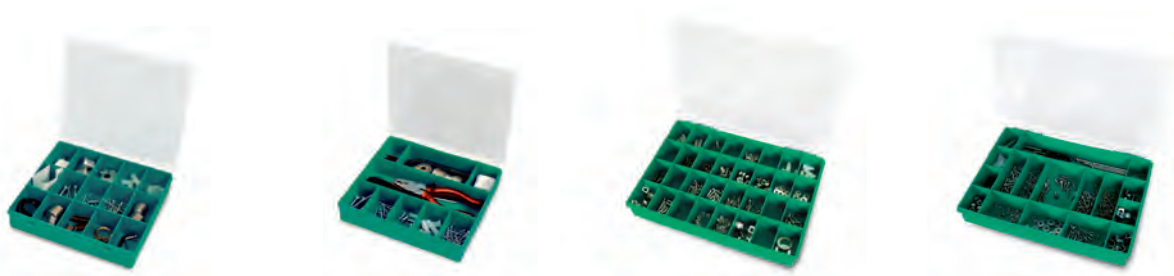

MODELO MODEL	33-15	33-9	13-32	13-17
CÓDIGO CODE	008009	009006	070105	071102
MEDIDAS SIZES	215 x 207 x 42mm	215 x 207 x 42mm	330 x 247 x 54 mm	330 x 247 x 54 mm
MATERIAL MATERIAL	PP	PP	PP	PP
EMBALAJE PACKING	12 unid.	12 unid.	6 unid.	6 unid.









MODELO MODEL	170-7	240-12	300-16	450-25	500-25
CÓDIGO CODE	012006	013003	014000	010002	011009
MEDIDAS SIZES	170 x 114 x 36 mm	240 x 155 x 41 mm	300 x 199 x 46 mm	387 x 230 x 49 mm	440 x 244 x 49 mm
CONTIENE CONTAINED	—	—	—	Separadores / 10 Dividers	Separadores / 10 Dividers
MATERIAL MATERIAL	PP	PP	PP	PP	PP
EMBALAJE PACKING	12 unid.	12 unid.	6 unid.	6 unid.	6 unid.



MODELO MODEL	23-1	25-1
CÓDIGO CODE	004001	006005
MEDIDAS SIZES	160 x 122 x 30 mm	178 x 140 x 34 mm
MATERIAL MATERIAL	PP	PP
EMBALAJE PACKING	24 unid.	24 unid.





MODELO MODEL	45-26	46-26	47-26	48-26
CÓDIGO CODE	145001	146008	147005	148002
MEDIDAS SIZES	312 x 238 x 51 mm	378 x 290 x 61 mm	460 x 350 x 81 mm	460 x 350 x 81 mm
CONTIENE CONTAINED	Separadores / 21 Dividers	Separadores / 21 Dividers	Separadores / 21 Dividers	Separadores / 21 Dividers
MATERIAL MATERIAL	PP	PP	PP	Base, separadores y cierres-PP. Tapa-POLICARBONATO (PC)
COLOR COLOUR				
EMBALAJE PACKING	6 unid.	6 unid.	5 unid.	5 unid.





MODELO MODEL	20-9	21-10	22-26	23-26	24-26
CÓDIGO CODE	020001	021008	022005	023002	024009
MEDIDAS SIZES	190 x 150 x 42 mm	256 x 192 x 42 mm	312 x 238 x 51 mm	388 x 290 x 61 mm	460 x 350 x 81 mm
CONTIENE CONTAINED	—	—	Separadores / 21 Dividers	Separadores / 21 Dividers	Separadores / 21 Dividers
MATERIAL MATERIAL	PP	PP	PP	PP	PP
EMBALAJE PACKING	12 unid.	12 unid.	6 unid.	6 unid.	5 unid.



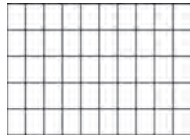

MODELO MODEL	430/50/50	430/50/25	430/50/0
CÓDIGO CODE	030000	031007	030406
MEDIDAS SIZES	430 x 370 x 55 mm	430 x 370 x 55 mm	430 x 370 x 55 mm
CONTIENE CONTAINED	Cajones 50/A50 Boxes	Cajones 10/A50 Boxes 10/B50 5/C50	Vacío Empty
MATERIAL MATERIAL	Base PP Base Tapa PS Cover Cajones PS Boxes	Base PP Base Tapa PS Cover Cajones PS Boxes	Base PP Base Tapa PS Cover
EMBALAJE PACKING	4 unid.	4 unid.	4 unid.



CAJONES EXTRAÍBLES

Removable Drawers



MODELO MODEL	A50	B50	C50
CÓDIGO CODE	040009	041006	042003
MEDIDAS SIZES	55 x 39 x 47 mm	79 x 55 x 47 mm	109 x 79 x 47 mm
EMBALAJE PACKING	300	150	75

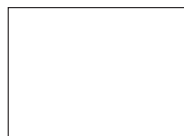
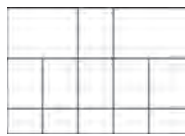

MODELO MODEL	430/80/25	430/80/13	430/80/0
CÓDIGO CODE	032004	033001	032400
MEDIDAS SIZES	430 x 370 x 85 mm	430 x 370 x 85 mm	430 x 370 x 85 mm
CONTIENE CONTAINED	Cajones 25/B80 Boxes	Cajones 5/B80 Boxes 6/C80 2/D80	Vacío Empty
MATERIAL MATERIAL	Base PP Base Tapa PS Cover Cajones PS Boxes	Base PP Base Tapa PS Cover Cajones PS Boxes	Base PP Base Tapa PS Cover
EMBALAJE PACKING	4 unid.	4 unid.	4 unid.

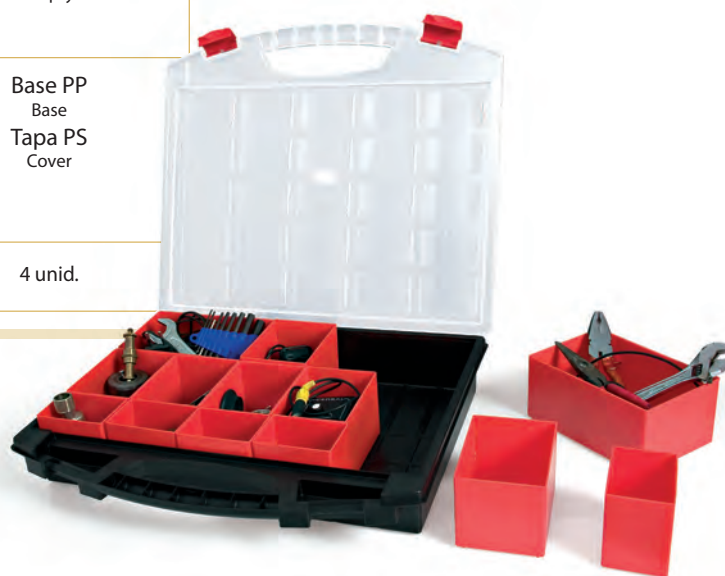

CAJONES EXTRAÍBLES

Removable Drawers



MODELO MODEL	B80	C80	D80
CÓDIGO CODE	043000	044007	045004
MEDIDAS SIZES	79 x 55 x 76 mm	109 x 79 x 76 mm	157 x 109 x 76 mm
EMBALAJE PACKING	90	45	21

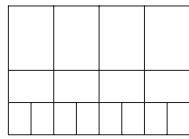
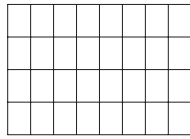



MODELO MODEL	330/50/32	330/50/16	330/50/0
CÓDIGO CODE	034008	035005	034404
MEDIDAS SIZES	330 x 247 x 54 mm	330 x 247 x 54 mm	330 x 247 x 54 mm
CONTIENE CONTAINED	Cajones 32/A50 Boxes	Cajones 8/A50 Boxes 4/B50 4/C50	Cajones Vacío Boxes Empty
MATERIAL MATERIAL	Base PP Base Tapa PP Cover Cajones PS Boxes	Base PP Base Tapa PP Cover Cajones PS Boxes	Base PP Base Tapa PP Cover
EMBALAJE PACKING	6 unid.	6 unid.	6 unid.



Home Collection 30l.

COLECCIÓN HOGAR 30L.



MODELO MODEL	Home collection	Home collection
CÓDIGO CODE	416590	417597
MEDIDAS SIZES	392 x 399 x 330 mm	392 x 399 x 330 mm
CAPACIDAD CAPACITY	30 l.	30 l.
MATERIAL MATERIAL	PP	PP
COLOR COLOUR		
EMBALAJE PACKING	5 unid.	5 unid.



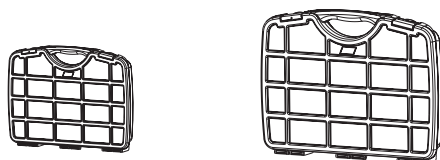

MODELO MODEL	22	23
CÓDIGO CODE	022593	023590
MEDIDAS SIZES	312 x 238 x 51 mm	388 x 290 x 61 mm
CONTIENE CONTAINED	Separadores 21 Dividers	Separadores 21 Dividers
MATERIAL MATERIAL	PP	PP
EMBALAJE PACKING	6 unid.	6 unid.



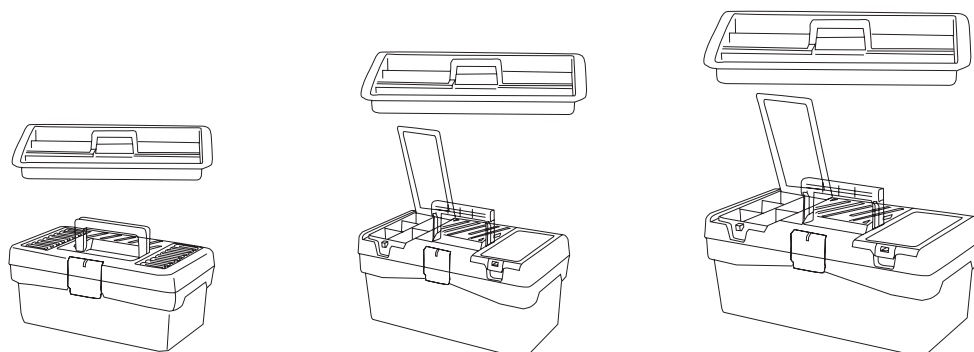

MODELO MODEL	12"	14"	16"
CÓDIGO CODE	110597	111594	112591
MEDIDAS SIZES	290 x 170 x 127 mm	356 x 192 x 150 mm	400 x 217 x 166 mm
CONTIENE CONTAINED	Bandeja Tray	Bandeja Tray	Bandeja Tray
MATERIAL MATERIAL	PP	PP	PP
EMBALAJE PACKING	10 unid.	6 unid.	6 unid.







MODELO MODEL	43
CÓDIGO CODE	143007
MEDIDAS SIZES	401 x 352 x 156 mm
CONTIENE CONTAINED	Separadores 20 Dividers
MATERIAL MATERIAL	PP
EMBALAJE PACKING	6 unid.

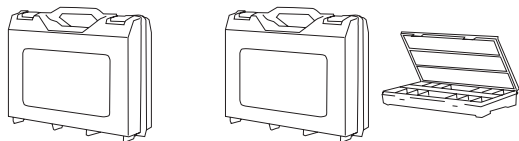

Cases for Electrical Tools

MALETAS HERRAMIENTAS ELÉCTRICAS



MODELO MODEL	40	41
CÓDIGO CODE	140006	141003
MEDIDAS SIZES	385 x 330 x 130 mm	385 x 330 x 130 mm
CONTIENE CONTAINED	Vacio Empty	Estuche 1 Box
MATERIAL MATERIAL	PP	PP
COLOR COLOUR		
EMBALAJE PACKING	7 unid.	7 unid.



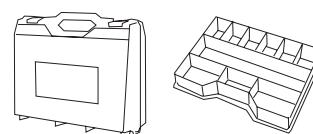

MALETAS HERRAMIENTAS MANUALES

Cases for Manual Tools



MODELO MODEL	42
CÓDIGO CODE	142000
MEDIDAS SIZES	385 x 330 x 130 mm
CONTIENE CONTAINED	Bandeja 1 Tray
MATERIAL MATERIAL	PP
EMBALAJE PACKING	7 unid.



MODELO MODEL	44	44-B
CÓDIGO CODE	144004	144998
MEDIDAS SIZES	430 x 370 x 140 mm	430 x 370 x 140 mm
CONTIENE CONTAINED	Vacio Empty	Bandeja Tray
MATERIAL MATERIAL	PP	PP
COLOR COLOUR		
EMBALAJE PACKING	4 unid.	4 unid.



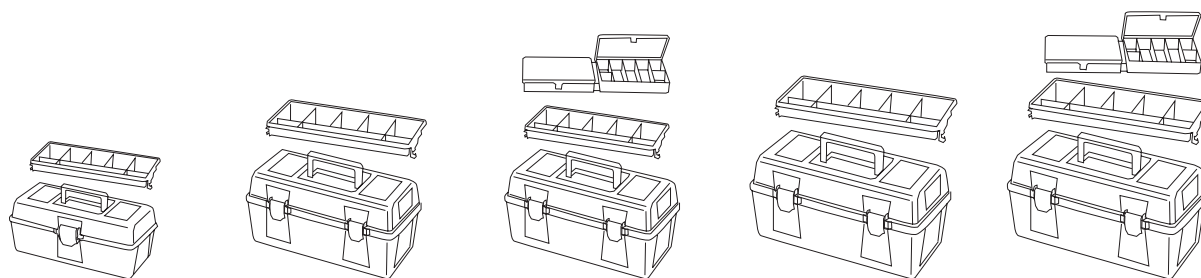

MODELO MODEL	21	22	23	24	25
CÓDIGO CODE	121005	122002	123009	124006	125003
MEDIDAS SIZES	310 x 160 x 130 mm	356 x 184 x 163 mm	356 x 184 x 163 mm	400 x 206 x 188 mm	400 x 206 x 188 mm
CONTIENE CONTAINED	Bandeja 1 Tray	Bandeja 1 Tray	Bandeja 1 Tray Estuche 1 Box	Bandeja 1 Tray	Bandeja 1 Tray Estuche 1 Box
MATERIAL MATERIAL	PP	PP	PP	PP	PP
EMBALAJE PACKING	10 unid.	6 unid.	6 unid.	6 unid.	6 unid.



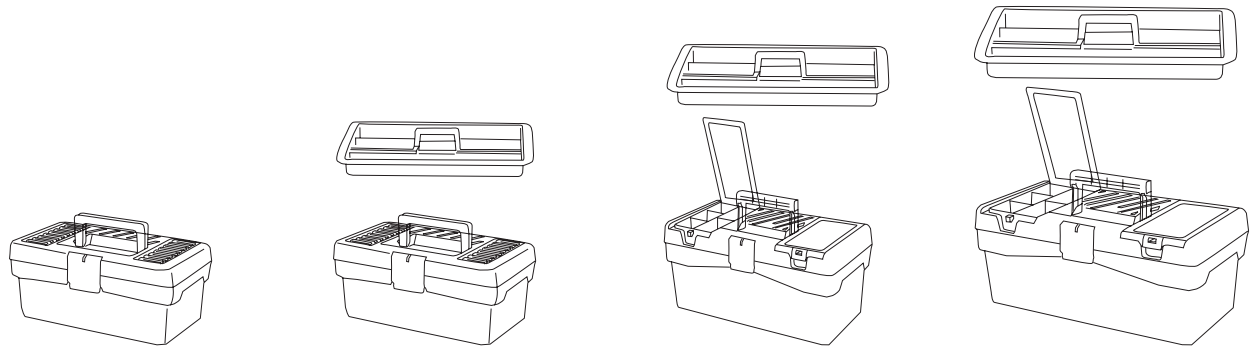

MODELO MODEL	9	10	11	12
CÓDIGO CODE	109003	110009	111006	112003
MEDIDAS SIZES	290 x 170 x 127 mm	290 x 170 x 127 mm	356 x 192 x 150 mm	400 x 217 x 166 mm
CONTIENE CONTAINED	Vacia Empty	Bandeja 1 Tray	Bandeja 1 Tray	Bandeja 1 Tray
MATERIAL MATERIAL	PP	PP	PP	PP
EMBALAJE PACKING	10 unid.	10 unid.	6 unid.	6 unid.





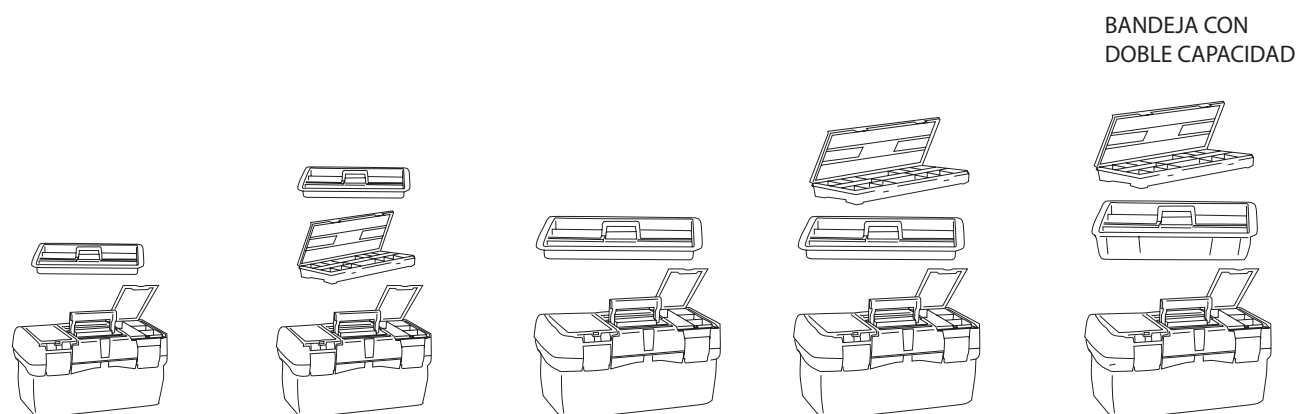

MODELO MODEL	15	16	17	18	19
CÓDIGO CODE	115004	116001	117008	118005	119002
MEDIDAS SIZES	500 x 258 x 255mm	500 x 258 x 255mm	580 x 290 x 290mm	580 x 290 x 290mm	580 x 290 x 290mm
CONTIENE CONTAINED	Bandeja 1 Tray	Bandeja 1 Tray Estuche 1 Box	Bandeja 1 Tray	Bandeja 1 Tray Estuche 1 Box	Bandeja 1 Tray Estuche 1 Box
MATERIAL MATERIAL	PP Cierres metálicos Metallics locks	PP Cierres metálicos Metallics locks	PP Cierres metálicos Metallics locks	PP Cierres metálicos Metallics locks	PP Cierres metálicos Metallics locks
EMBALAJE PACKING	3 unid.	3 unid.	3 unid.	3 unid.	3 unid.
UNIDAD BOX PALET BOX - PALET UNIT	24	24	24	24	24
MEDIDAS BOX PALET BOX - PALET SIZE	1000 x 772 x 1016 mm	1000 x 772 x 1016 mm	1160 x 804 x 1160 mm	1160 x 804 x 1160 mm	1160 x 804 x 1160 mm

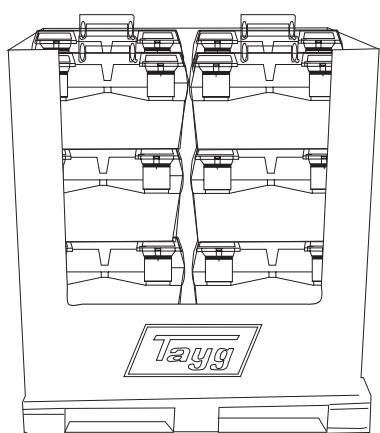

OPCIÓN BOX PALET
BOX - PALET OPTION





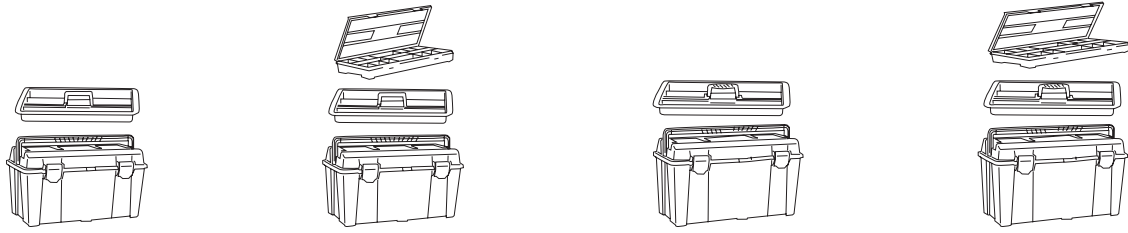

MODELO MODEL	30	31	32	33
CÓDIGO CODE	130007	131004	132001	133008
MEDIDAS SIZES	445 x 235 x 230 mm	445 x 235 x 230 mm	480 x 258 x 255 mm	480 x 258 x 255 mm
CONTIENE CONTAINED	Bandeja 1 Tray	Bandeja 1 Tray Estuche 1 Box	Bandeja 1 Tray	Bandeja 1 Tray Estuche 1 Box
MATERIAL MATERIAL	PP	PP	PP	PP
EMBALAJE PACKING	6 unid.	6 unid.	3 unid.	3 unid.



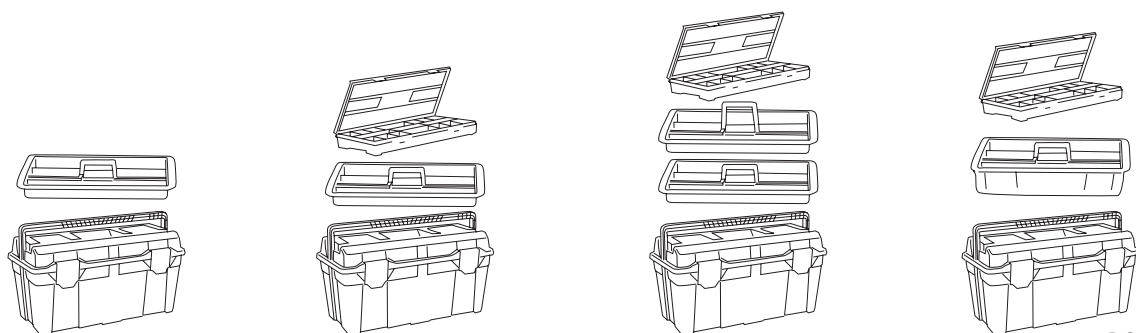

BANDEJA CON DOBLE CAPACIDAD

MODELO MODEL	34-1B	34	35	36
CÓDIGO CODE	134999	134005	135002	136009
MEDIDAS SIZES	580 x 285 x 290 mm	580 x 285 x 290 mm	580 x 285 x 290 mm	580 x 285 x 290 mm
CONTIENE CONTAINED	Bandeja 1 Tray	Bandeja 1 Tray Estuche 1 Box	Bandeja 2 Tray Estuche 1 Box	Bandeja 1 Tray Estuche 1 Box
MATERIAL	PP	PP	PP	PP
EMBALAJE PACKING	3 unid.	3 unid.	3 unid.	3 unid.



149009 ACCESORIO-CINTA Y SOPORTES
ACCESSORY-STRAP, FRAME

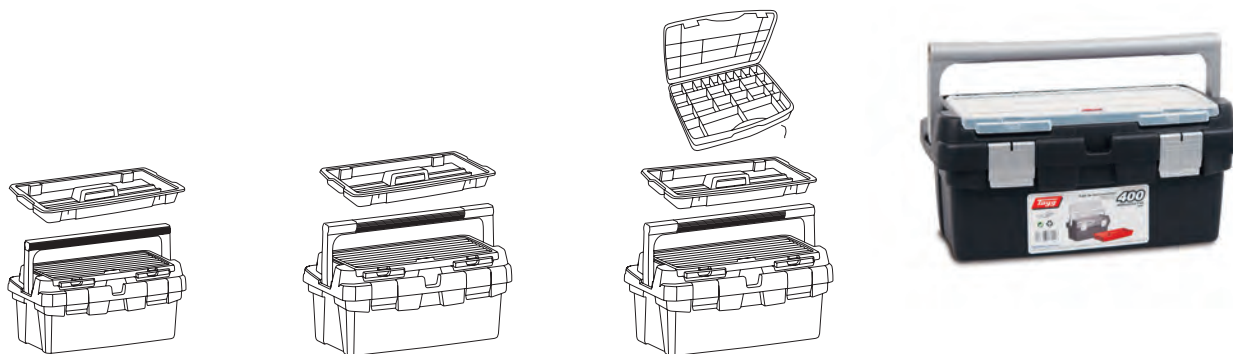

MODELO MODEL	400	450	450-E
CÓDIGO CODE	162008	163005	164002
MEDIDAS SIZES	400x225x190 mm	450x285x250 mm	450x285x250 mm
CONTIENE CONTAINED	Bandeja 1 Tray	Bandeja 1 Tray	Bandeja 1 Tray Estuche 1 Box
MATERIAL MATERIAL	PP	PP Asa Aluminio Aluminium handle Cierres metálicos Metallic locks	PP Asa Aluminio Aluminium handle Cierres metálicos Metallic locks
EMBALAJE PACKING	6 unid.	3 unid.	3 unid.



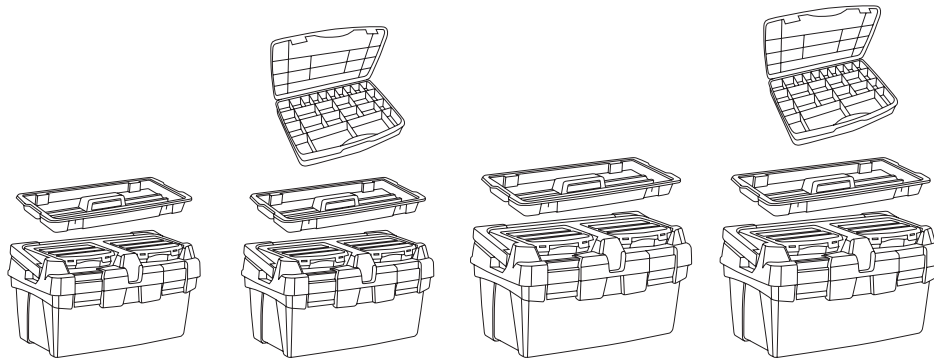

MODELO MODEL	500	500-E	600	600-E
CÓDIGO CODE	165009	166006	167003	168000
MEDIDAS SIZES	500x295x270 mm	500x295x270 mm	600x305x295 mm	600x305x295 mm
CONTIENE CONTAINED	Bandeja 1 Tray	Bandeja 1 Tray Estuche 1 Box	Bandeja 1 Tray	Bandeja 1 Tray Estuche 1 Box
MATERIAL MATERIAL	PP Asa Aluminio Aluminium handle Cierres metálicos Metallics locks	PP Asa Aluminio Aluminium handle Cierres metálicos Metallics locks	PP Asa Aluminio Aluminium handle Cierres metálicos Metallics locks	PP Asa Aluminio Aluminium handle Cierres metálicos Metallics locks
EMBALAJE PACKING	3 unid.	3 unid.	3 unid.	3 unid.





MODELO MODEL	AccessoryBox 01	AccessoryBox 02	AccessoryBox 03	Power tools 43
CÓDIGO CODE	022555	023552	024559	143557
MEDIDAS SIZES	312x238x51 mm	388x290x61 mm	460x350x81 mm	401x352x156 mm
CONTIENE CONTAINED	21 Separadores 21 Dividers	21 Separadores 21 Dividers	21 Separadores 21 Dividers	20 Separadores 20 Dividers
EMBALAJE PACKING	6 unid.	6 unid.	5 unid.	6 unid.
MEDIDAS EMBALAJE PACKING SIZES	310x244x320 mm	392x294x370 mm	405x356x470 mm	708x404x474 mm
CANTIDAD MÍNIMA MINIMUM QUANTITY	462 unid.	288 unid.	150 unid.	90 unid.





MODELO MODEL	ToolBox 12"	ToolBox 16"	ToolBox 20"	ToolBox 23"
CÓDIGO CODE	110559	112553	115554	117558
MEDIDAS SIZES	290x170x127 mm	400x217x166 mm	500x258x255 mm	580x290x290 mm
CONTIENE CONTAINED	Bandeja 1 1 Tray	Bandeja 1 1 Tray	Bandeja 1 1 Tray	Bandeja 1 1 Tray
EMBALAJE PACKING	10 unid.	6 unid.	3 unid.	3 unid.
MEDIDAS EMBALAJE PACKING SIZES	780 x 294 x 260 mm	600 x 404 x 340 mm	720 x 264 x 510 mm	795 x 290 x 584 mm
CANTIDAD MÍNIMA MINIMUM QUANTITY	360 unid.	168 unid.	54 unid.	48 unid.



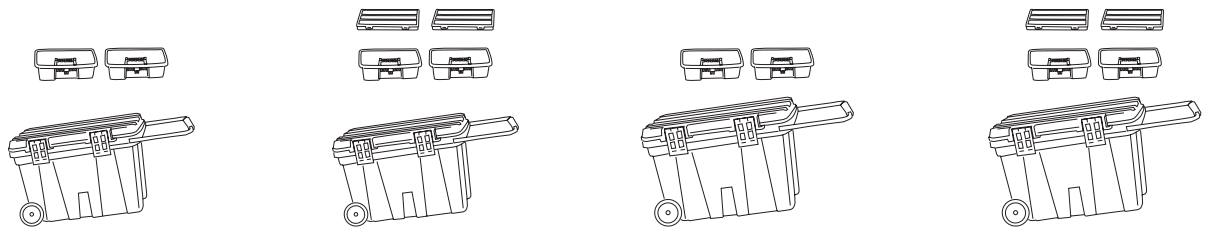

MODELO MODEL	50	51	53	54
CÓDIGO CODE	150005	151002	153006	154003
MEDIDAS SIZES	675x472x416 mm	675x472x416 mm	775x472x493 mm	775x472x493 mm
CONTIENE CONTAINED	Bandeja 2 Tray Palomillas 5 Small Bracket	Bandeja 2 Tray Estuches 2 Boxes	Bandeja 2 Tray Palomillas 5 Small Bracket	Bandeja 2 Tray Estuches 2 Boxes
MATERIAL MATERIAL	PP	PP	PP	PP
EMBALAJE PACKING	1 unid.	1 unid.	1 unid.	1 unid.



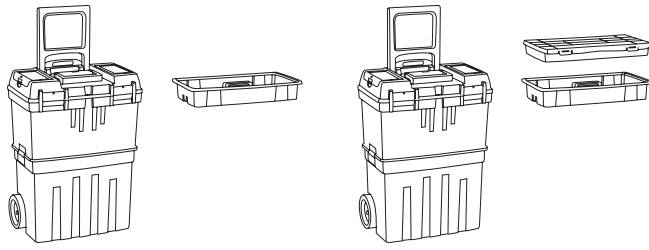

MODELO MODEL	57	58
CÓDIGO CODE	157004	158001
MEDIDAS SIZES	470x290x630 mm	470x290x630 mm
CONTIENE CONTAINED	Bandeja 1 Tray	Bandeja 1 Tray Estuches 1 Boxes
MATERIAL MATERIAL	PP	PP Cierres metálicos Metallic locks
EMBALAJE PACKING	1 unid.	1 unid.





MODELO MODEL	59
CÓDIGO CODE	159008
MEDIDAS SIZES	500x410x770 mm
CONTIENE CONTAINED	1 estuche 430/50/25 1 estuche 430/80/13 1 estuche 430/80/0 1 maleta 44B 1 maleta cajón
MATERIAL MATERIAL	PP Cajones y tapa transparente-PS
EMBALAJE PACKING	1 unid.



TRAIL BOX PROF





MODELO MODEL	403	505
CÓDIGO CODE	185007	188008
MEDIDAS SIZES	404x200x240 mm	500x200x290 mm
DEPARTAMENTOS CONTAINED	3	5
MATERIAL MATERIAL	Chapa de acero Pintura epoxi Steel Sheet	Chapa de acero Pintura epoxi Steel Sheet
EMBALAJE PACKING	1 unid.	1 unid.





MODELO MODEL	CT-0	CT-1	CT-2	CT-5
CÓDIGO CODE	194009	190001	193002	191008
MEDIDAS SIZES	820x365x900 mm	935x385x985 mm	735x370x835 mm	750x460x850 mm
CAJONES Y MEDIDAS DRAWERS & SIZES	0	1	2	2 (582x382x125) 3 (582x382x55)
MATERIAL MATERIAL	Chapa de acero Pintura epoxi Steel Sheet	Chapa de acero Pintura epoxi Steel Sheet	Chapa de acero Pintura epoxi Steel Sheet	Chapa de acero Pintura epoxi Steel Sheet
PESO WEIGHT	14 kg	24 kg	28 kg	43 kg
EMBALAJE PACKING	1 unid.	1 unid.	1 unid.	1 unid.



RUEDAS

Casters



CÓDIGO CODE	195006	196003	197000
CONTIENE CONTAINED	2 ruedas móviles con freno 2 ruedas fijas Tornillería 2 Mobile casters with brake 2 Fixed casters Screws	2 ruedas móviles con freno 2 ruedas fijas Tornillería 2 Mobile casters with brake 2 Fixed casters Screws	2 ruedas móviles con freno 2 ruedas fijas Tornillería 2 Mobile casters with brake 2 Fixed casters Screws
VÁLIDO PARA VALID FOR	CT0-CT1	CT2	CT5



Con 4 tacos de apoyo en el fondo.
With 4 rubber feet the bottom.

MODELO MODEL	Bolsa Herramientas BN-1 (13") Nylon Tool Bag BN-1(13")
CÓDIGO CODE	080005
MEDIDAS SIZES	345x220x225 mm
MATERIAL MATERIAL	Poliester 600D Polyester 600D
EMBALAJE PACKING	6 unid. 6 pcs.



MODELO MODEL	Bolsa Herramientas BN-3 (18") Nylon Tool Bag BN-3(18")
CÓDIGO CODE	082009
MEDIDAS SIZES	455x250x265 mm
MATERIAL MATERIAL	Bolsa Poliester 900D-Fondo Politeno Polyester 900D Bag-Base Polytene
EMBALAJE PACKING	6 unid. 6 pcs.



MODELO MODEL	Bolsa Herramientas BN-5 (13") Nylon Tool Bag BN-5(13")
CÓDIGO CODE	095009
MEDIDAS SIZES	335x200x290 mm
MATERIAL MATERIAL	Poliester 900D Polyester 900D
EMBALAJE PACKING	6 unid. 6 pcs.



MODELO MODEL	Bolsa Herramientas BN-6 (17") Nylon Tool Bag BN-6(17")
CÓDIGO CODE	096006
MEDIDAS SIZES	420x220x290 mm
MATERIAL MATERIAL	Poliester 900D Polyester 900D
EMBALAJE PACKING	6 unid. 6 pcs.



MODELO MODEL	Bolsillo herramientas doble Double tool pouch
CÓDIGO CODE	090608
MATERIAL MATERIAL	Poliester 600D Polyester 600D
EMBALAJE PACKING	6 unid. 6 pcs.



MODELO MODEL	Bolsillo herramientas simple Simple tool pouch
CÓDIGO CODE	089602
MATERIAL MATERIAL	Poliester 600D Polyester 600D
EMBALAJE PACKING	10 unid. 10 pcs.



MODELO MODEL	Bolsillo herramientas simple-profesional Professional simple tool pouch
CÓDIGO CODE	091605
MATERIAL MATERIAL	Poliester 900D Polyester 900D
EMBALAJE PACKING	10 unid. 10 pcs.



MODELO MODEL	Bolsillo herramientas doble-profesional Professional double tool pouch
CÓDIGO CODE	092602
MATERIAL MATERIAL	Poliester 900D Polyester 900D
EMBALAJE PACKING	6 unid. 6 pcs.